

CARRIAGE SIDE

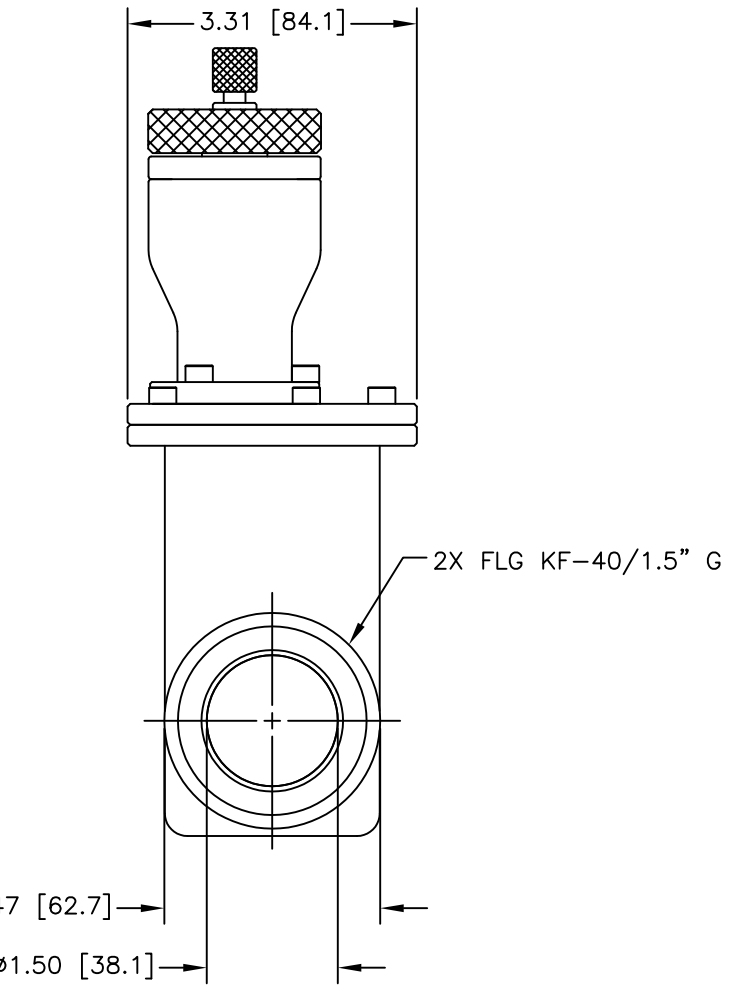

GATE (SEAL) SIDE

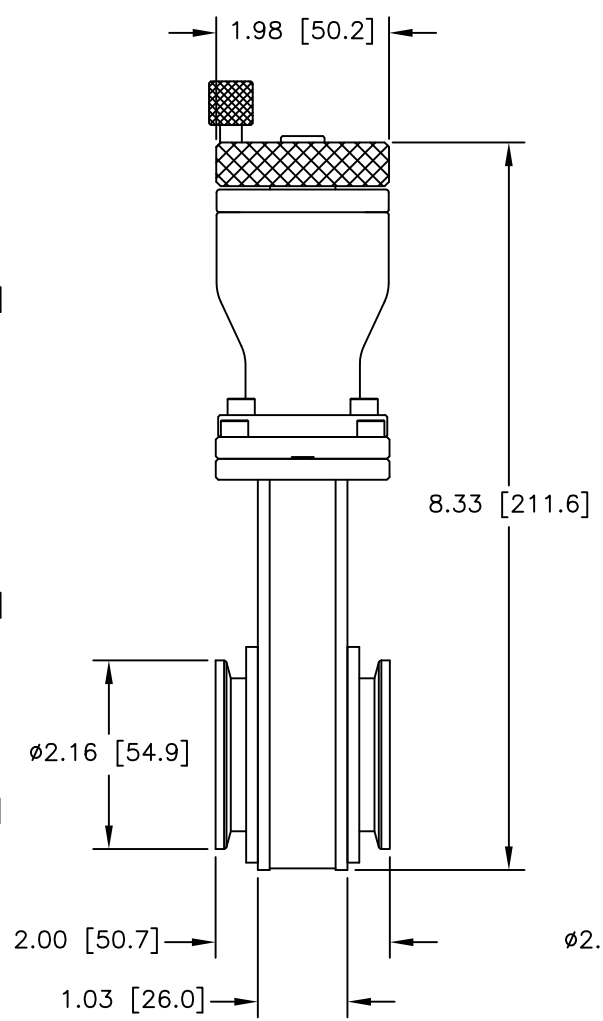

12880 MOYA BLVD., RENO, NV 89506

OUTLINE DIMENSION DRAWING

DRAWING NUMBER  
6302-3CT

DRAWING TITLE  
G 1.5" STD/MAN/KF  
MODEL # 11110-0153

REVISION  
C