

A1557-3-CF

REV  
5/2/2013

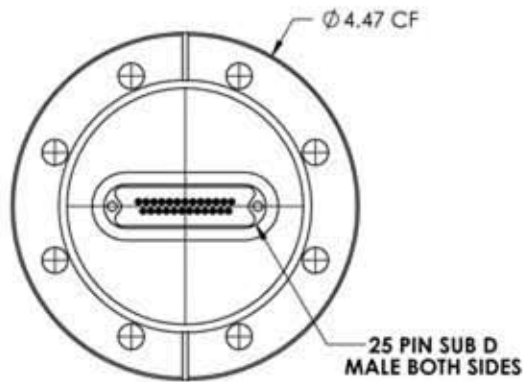

APPROVED

Subminiature D-type Multipin Feedthrough, 25 Pins, 500 Volts, 5 Amps per Pin, 4.50" Conflat Flange

TITLE:

MULTIPIN, TYPE-D, 500V, 5A  
25 PIN, 450CF

<b>PROPRIETARY AND CONFIDENTIAL</b>		<b>UNLESS OTHERWISE SPECIFIED:</b>		<b>MPF PRODUCTS INC.</b>				
ANY REPRODUCTION IN PART OR AS A WHOLE WITHOUT THE WRITTEN PERMISSION OF MPF PRODUCTS INC. IS PROHIBITED.		DIMENSIONS ARE IN INCHES TOLERANCES:			FINISH	DRAWN BY	JB	DATE
USED ON:		ANGULAR: MACH ± 1/2 ° TWO PLACE DECIMAL THREE PLACE DECIMAL			CONFLAT	CHECKED		
		±.030 ±.015		DO NOT SCALE DRAWING	ENG APPR.	JB		DWG. NO. <b>A1557-3-CF</b>
								REV 5/2/2013
							LAST SAVED DATE	Thursday, April 25, 2013 8:49:28 AM